

How to Measure Sky Lounger Covers - Design 4

Measurement Instruction

- ✓ Give exact measurement from edge to edge.
- ✓ "We add upto 2" leeway on the given width/depth for easy pull-in and pull-out."
- ✓ The height dimensions will remain same as provided by you.

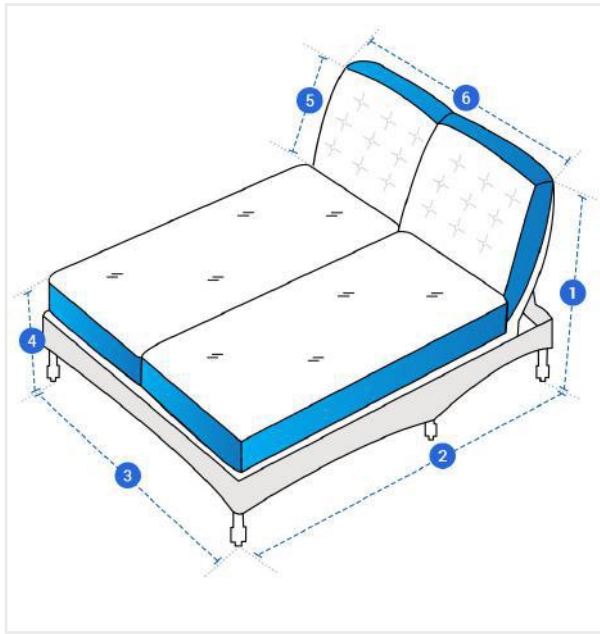

Measurement (Inches)

1. Back Height

2. Depth

3. Front Width

4. Front Height

5. Slant Height

6. Back Width

1. Back Height:

Back Height of the Sky Lounger

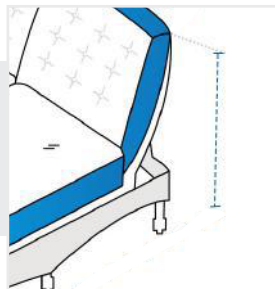

2. Depth:

Depth of the Sky Lounger

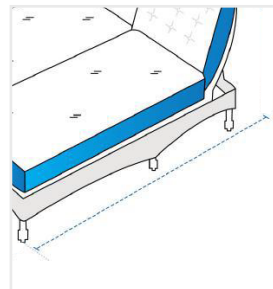

3. Front Width:

Front Width of the Sky Lounger

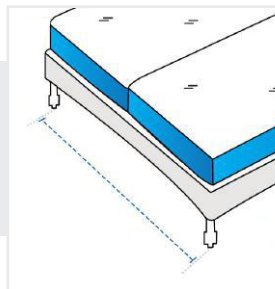

4. Front Height:

Front Height of the Sky Lounger

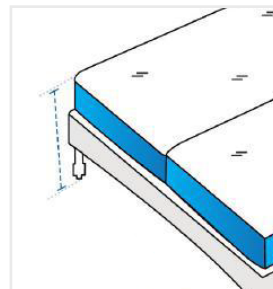

5. Slant Height:

Slant Height of the Sky Lounger

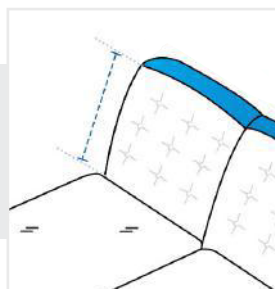

6. Back Width:

Back Width of the Sky Lounger

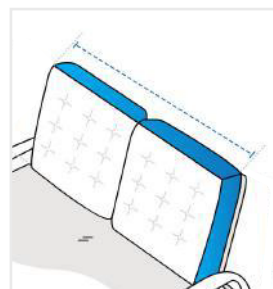

We encourage you to upload the image of the article you need the cover for - this helps our team ensure covers are designed keeping your requirements in mind.