

How to Measure Rectangular Fire Pit Covers - Design 3

Measurement Instruction

- ✓ Give exact measurement from edge to edge.
- ✓ "We add upto 2" leeway on the given width/depth for easy pull-in and pull-out."
- ✓ The height dimensions will remain same as provided by you.

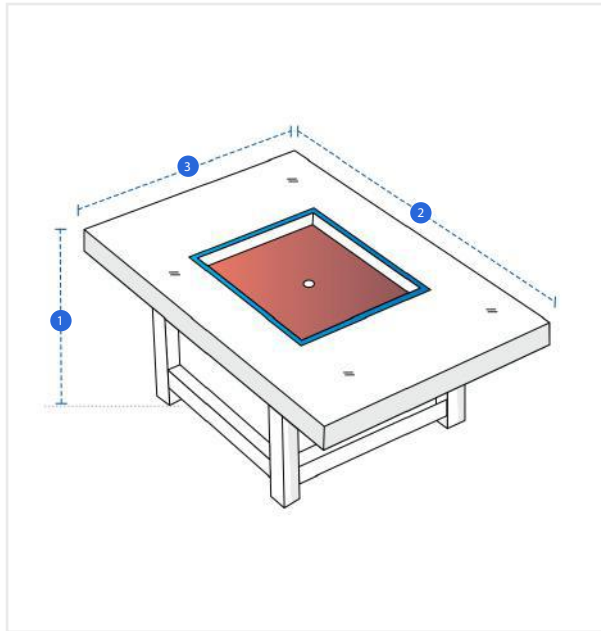

Measurement (Inches)

1. Height

2. Width

3. Depth

1. Height:

Height of the Fire Pit

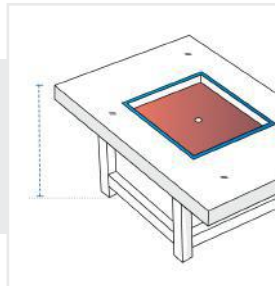

2. Width:

Width of the Fire Pit

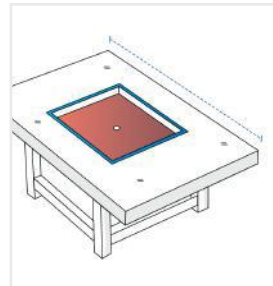

3. Depth:

Depth of the Fire Pit

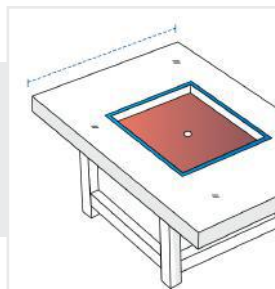

We encourage you to upload the image of the article you need the cover for - this helps our team ensure covers are designed keeping your requirements in mind.