

How to Measure Mesh Custom Sandbox Covers - With 6 Pole Cut-Out

Measurement Instruction

- ✓ Give exact measurement from edge to edge.
- ✓ The Final size can be +1" to 2" on the given Width and Length
- ✓ The height dimensions will remain same as provided by you.

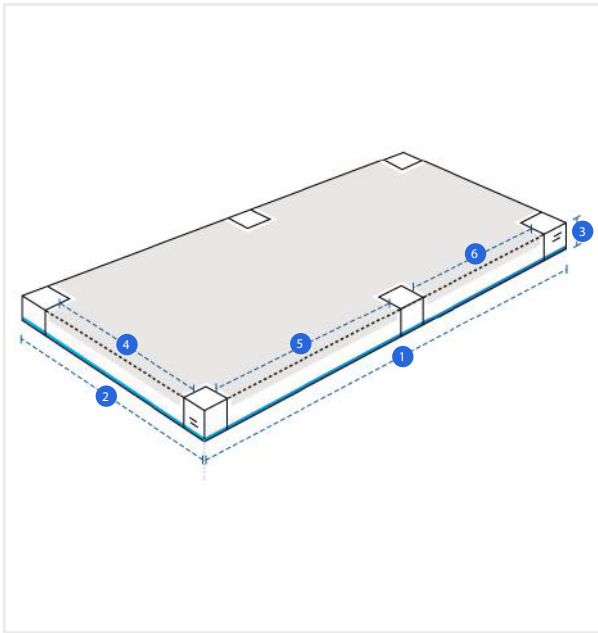

Measurement (Inches)

1. Total Length

3. Height

5. Length Between 2 Poles - A

2. Total Width

4. Width Between 2 Poles

6. Length Between 2 Poles - B

1. Total Length:
Total Length of the Mesh Custom Sandbox Covers

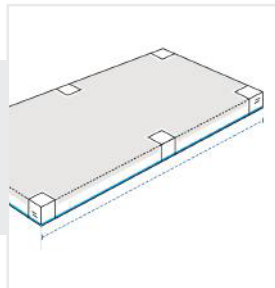

2. Total Width:
Total Width of the Mesh Custom Sandbox Covers

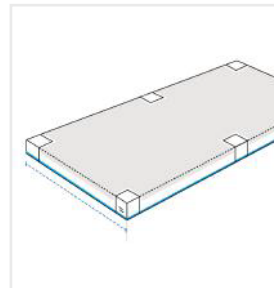

3. Height:
Height of the Mesh Custom Sandbox Covers

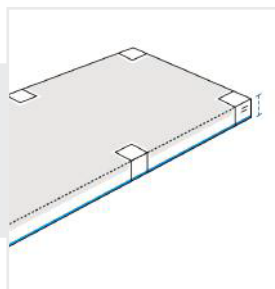

4. Width Between 2 Poles:
Width Between 2 Poles of the Mesh Custom Sandbox Covers

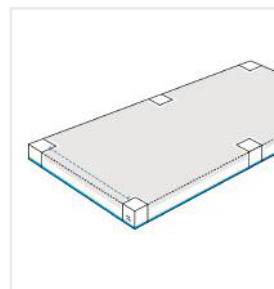

5. Length Between 2 Poles - A:
Length Between 2 Poles - A of the Mesh Custom Sandbox Covers

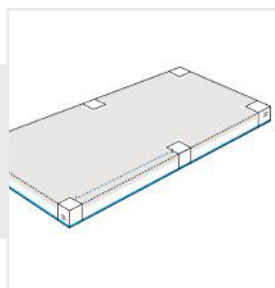

6. Length Between 2 Poles - B:
Length Between 2 Poles - B of the Mesh Custom Sandbox Covers

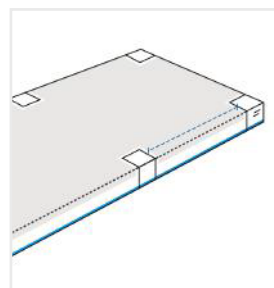

We encourage you to upload the image of the article you need the cover for - this helps our team ensure covers are designed keeping your requirements in mind.