

## How to Measure Custom Gas Snowblower Cover

### Measurement Instruction

- ✓ Give exact measurement from edge to edge.
- ✓ We add 1" to 2" leeway on the given width/depth for easy pull-in and pull-out.
- ✓ The height dimensions will remain same as provided by you.

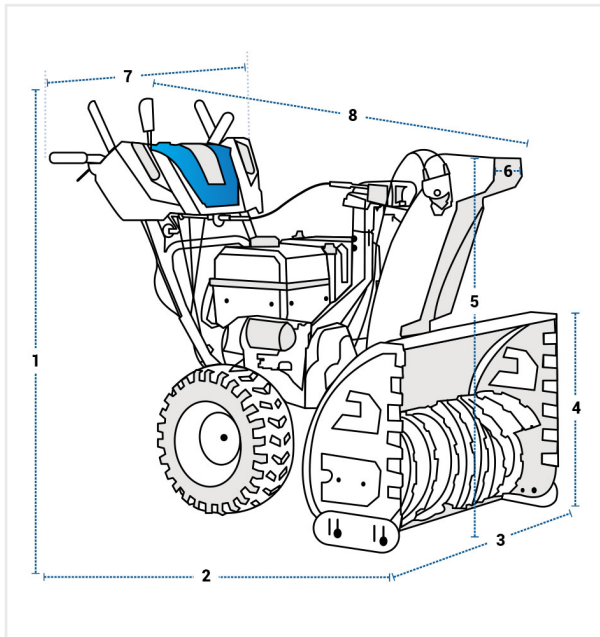

### Measurement (Inches)

1. Back Height	<input type="text"/>	2. Depth	<input type="text"/>
3. Front Width	<input type="text"/>	4. Front Height #1	<input type="text"/>
5. Front Height	<input type="text"/>	6. Chute Width	<input type="text"/>
7. Back Width	<input type="text"/>	8. Depth #1	<input type="text"/>

#### 1. Back Height:

Back Height of the Custom Gas Snowblower

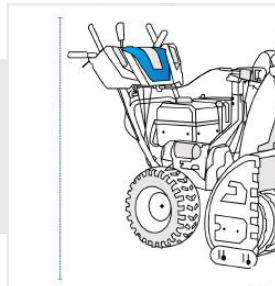

#### 2. Depth:

Depth of the Custom Gas Snowblower

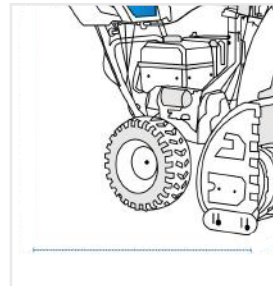

#### 3. Front Width:

Front Width of the Custom Gas Snowblower

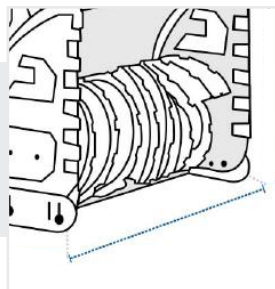

#### 4. Front Height #1:

Front Height (Side #1)

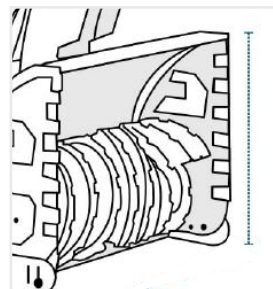

#### 5. Front Height:

Front Height of the Custom Gas Snowblower

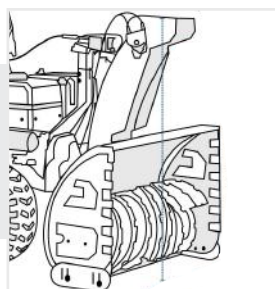

#### 6. Chute Width:

Chute Width of the Custom Gas Snowblower

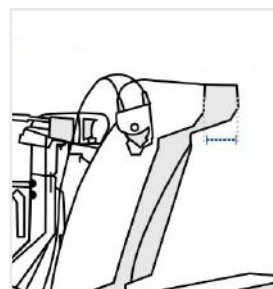

## 7. Back Width:

Back Width of the  
Custom Gas Snowblower

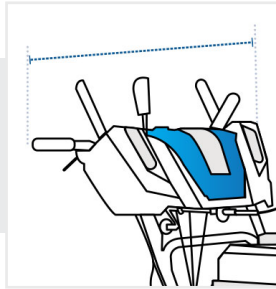

## 8. Depth #1:

Depth of the Gas  
Snowblower(Side #1)

