

How to Measure Custom Log Splitter Covers - Kinetic Gas Log Splitter

Measurement Instruction

- ✓ Give exact measurement from edge to edge.
- ✓ We add 1" to 2" leeway on the given width/depth for easy pull-in and pull-out.
- ✓ The height dimensions will remain same as provided by you.
- ✓ All measurements will be done in inches.

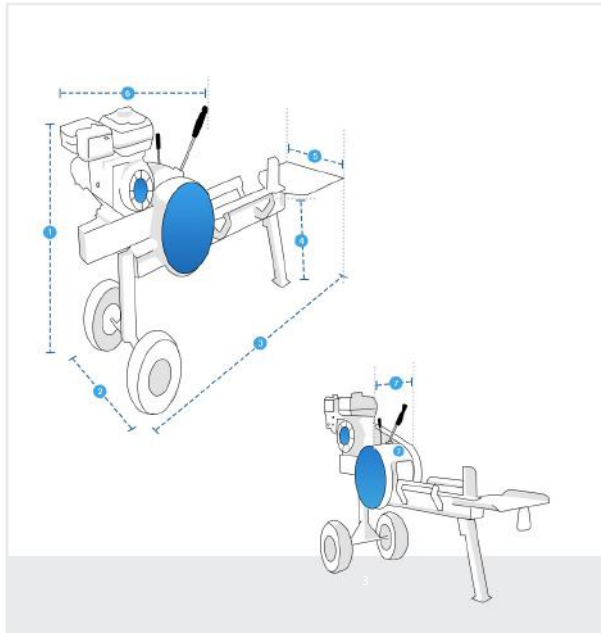

Measurement (Inches)

1. Height

2. Width between tyres from outer edge

3. Length

4. Height of rack from ground

5. Width of wood catcher

6. Depth from back till lever

7. Width of flywheels

1. Height:
Height of the Log Splitter

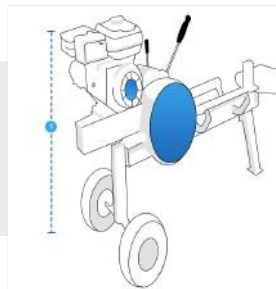

2. Width between tyres from outer edge:
Width between tyres from outer edge of the Log Splitter

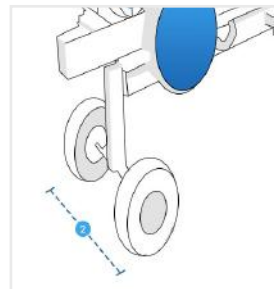

3. Length:
Length of the Log Splitter

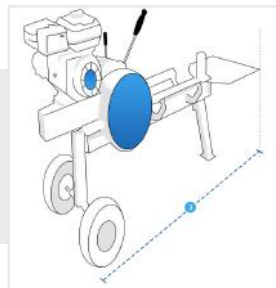

4. Height of rack from ground:
Height of rack from ground of the Log Splitter

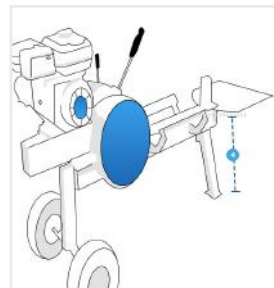

We encourage you to upload the image of the article you need the cover for - this helps our team ensure covers are designed keeping your requirements in mind.

How to Measure Custom Log Splitter Covers - Kinetic Gas Log Splitter

Measurement Instruction

- ✓ Give exact measurement from edge to edge.
- ✓ We add 1" to 2" leeway on the given width/depth for easy pull-in and pull-out.
- ✓ The height dimensions will remain same as provided by you.
- ✓ All measurements will be done in inches.

5. Width of wood catcher:

Width of wood catcher of the Log Splitter

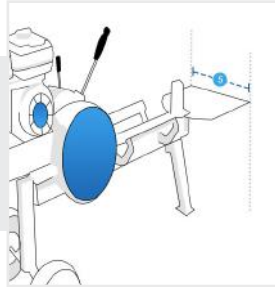

6. Depth from back till lever:

Depth from back till lever of the Log Splitter

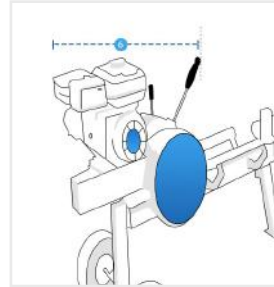

7. Width of flywheels:

Width of flywheels of the Log Splitter

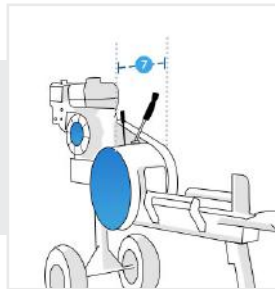

We encourage you to upload the image of the article you need the cover for - this helps our team ensure covers are designed keeping your requirements in mind.