

# How to Measure Custom Chimney Cover - Design 8

## Measurement Instruction

- ✓ Give exact measurement from edge to edge.
- ✓ We add 1" to 2" leeway on the given width/depth for easy pull-in and pull-out.
- ✓ The height dimensions will remain same as provided by you.

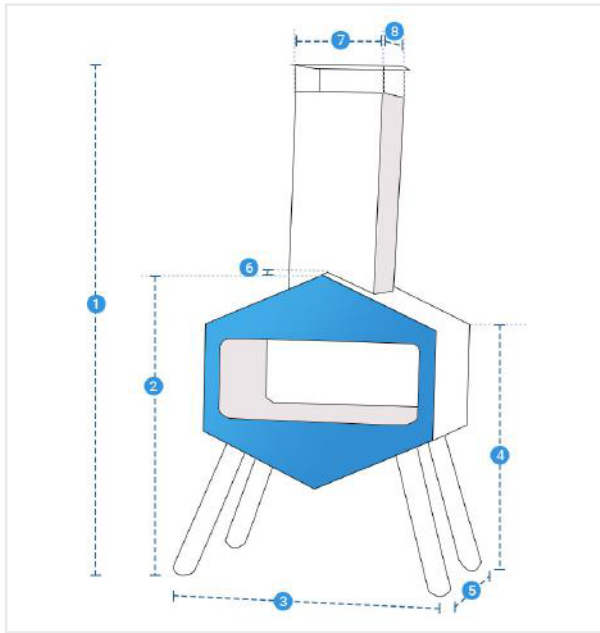

### Measurement (Inches)

1. Height	<input type="text"/>	2. Height till Chimney Pipe Bottom	<input type="text"/>
3. Bottom Width	<input type="text"/>	4. Height till Edge	<input type="text"/>
5. Bottom Depth	<input type="text"/>	6. Depth from Chimney Pipe	<input type="text"/>
7. Width of Chimney Pipe	<input type="text"/>	8. Depth of Chimney Pipe	<input type="text"/>

**1. Height:**  
Height of the Custom Chimney

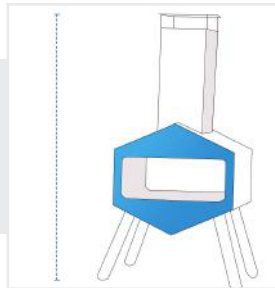

**2. Top Hexagonal Slant Length 1:**  
Top Hexagonal Slant Length 1 of the Custom Chimney

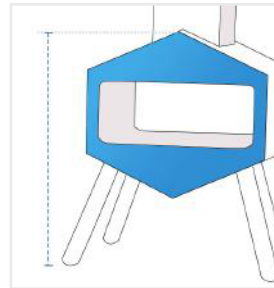

**3. Bottom Width:**  
Bottom Width of the Custom Chimney

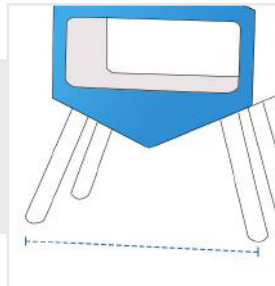

**4. Height till Edge:**  
Height till Edge of the Custom Chimney

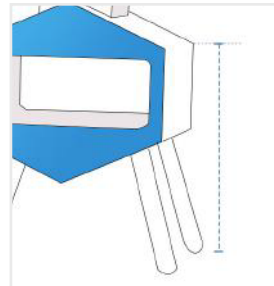

**5. Bottom Depth:**  
Bottom Depth of the Custom Chimney

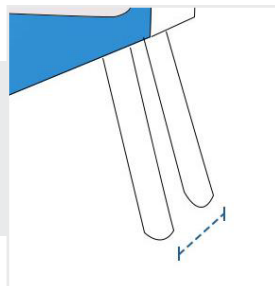

**6. Depth from Chimney Pipe:**  
Depth from Chimney Pipe of the Custom Chimney

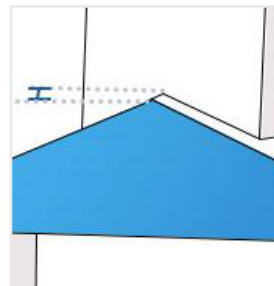

## 7. Width of Chimney Pipe:

Width of Chimney Pipe of the Custom Chimney

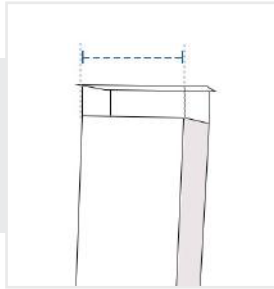

## 8. Depth of Chimney Pipe:

Depth of Chimney Pipe of the Custom Chimney

