

How to Measure Custom Log Splitter Covers - Dual Action Log Splitter

Measurement Instruction

- ✓ Give exact measurement from edge to edge.
- ✓ We add 1" to 2" leeway on the given width/depth for easy pull-in and pull-out.
- ✓ The height dimensions will remain same as provided by you.

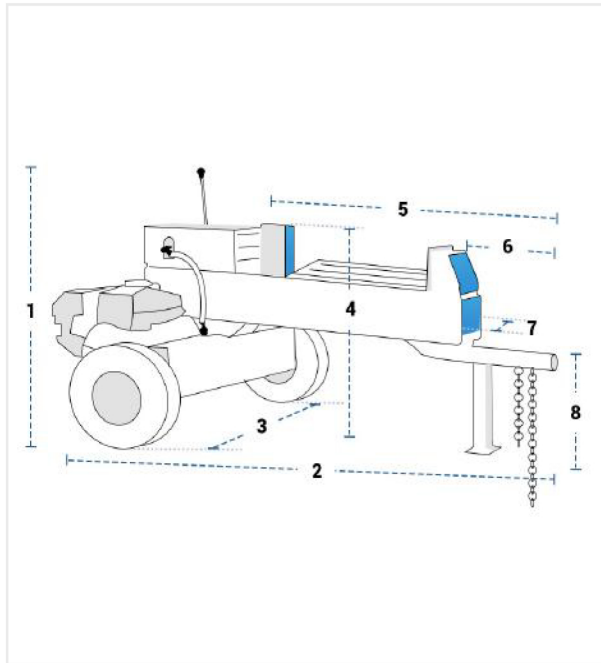

Measurement (Inches)

1. Height	<input type="text"/>	2. Length	<input type="text"/>
3. Width Between Tires from Outer Edge	<input type="text"/>	4. Height Without Lever	<input type="text"/>
5. Length of Rack till Tow Point	<input type="text"/>	6. Front Length #1	<input type="text"/>
7. Width at the Front	<input type="text"/>	8. Height of Tow Point from Ground	<input type="text"/>

1. Height:
Height of the Log Splitter

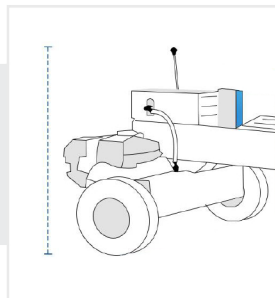

2. Length:
Length of the Log Splitter

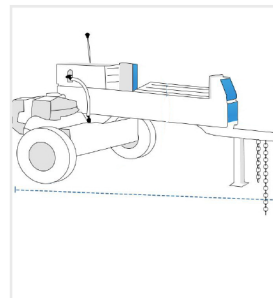

3. Width Between Tires from Outer Edge:
Width Between Tires from Outer Edge of the Log Splitter

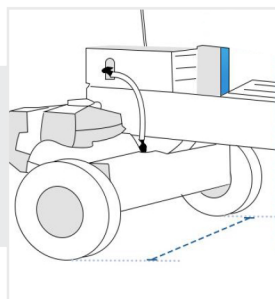

4. Height Without Lever:
Height Without Lever of the Log Splitter

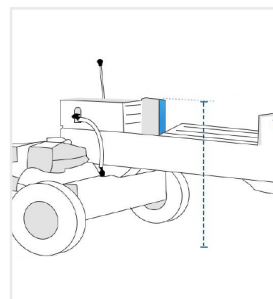

5. Length of Rack till Tow Point:
Length of Rack till Tow Point of the Log Splitter

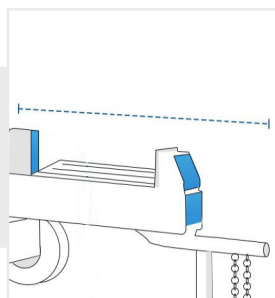

6. Front Length #1:
Front Length (Side #1)

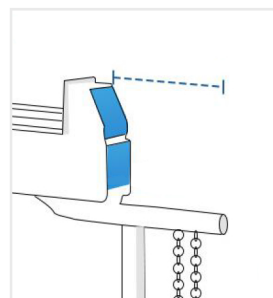

7. Width at the Front:
Width at the Front of the
Log Splitter

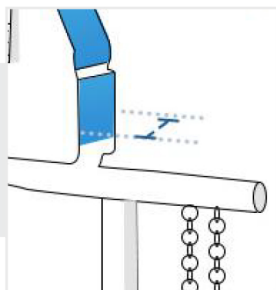

8. Height of Tow Point from Ground:
Height of Tow Point from Ground of the
Log Splitter

