

# How to Measure Custom Adirondack Chair Covers - Design 3

## Measurement Instruction

- ✓ Give exact measurement from edge to edge.
- ✓ We add 1" to 2" leeway on the given width/depth for easy pull-in and pull-out.
- ✓ The height dimensions will remain same as provided by you.

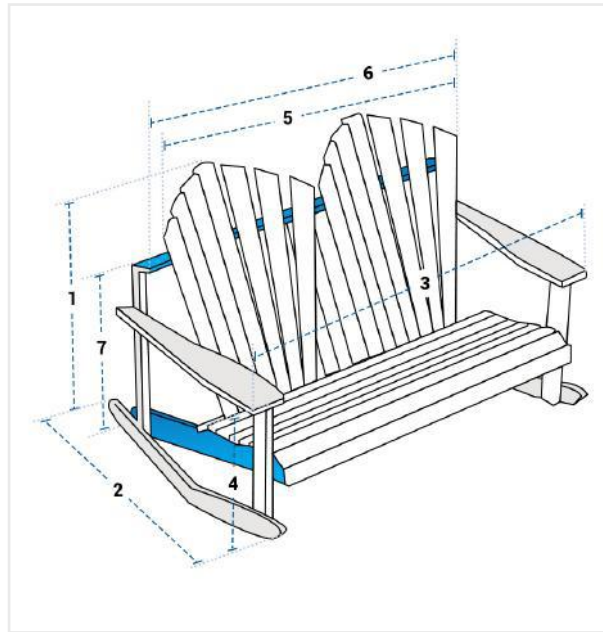

### Measurement (Inches)

1. Back Height

3. Arm to Arm Width

5. Back Width

7. Height #1

2. Depth

4. Front Height

6. Width #1

**1. Back Height:**  
Back Height of the Custom Adirondack Chair

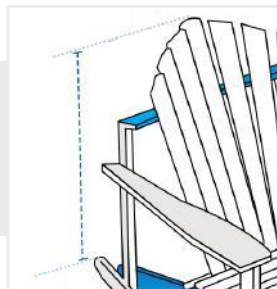

**2. Depth:**  
Depth of the Custom Adirondack Chair

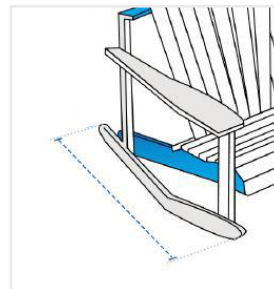

**3. Arm to Arm Width:**  
Arm to Arm Width of the Custom Adirondack Chair

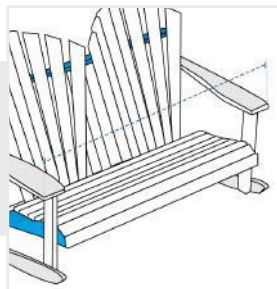

**4. Front Height:**  
Front Height of the Custom Adirondack Chair

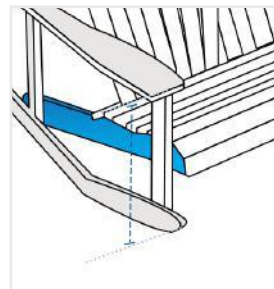

**5. Back Width:**  
Back Width of the Custom Adirondack Chair

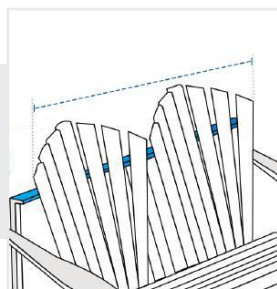

**6. Width #1:**  
Width (side #1)

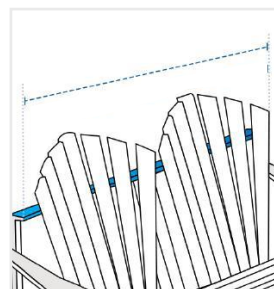

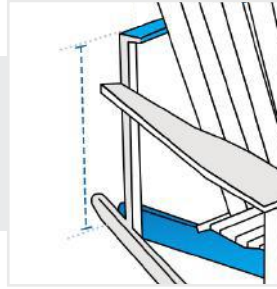

**7. Height #1:**  
Height (Side#1)

We encourage you to upload the image of the article you need the cover for - this helps our team ensure covers are designed keeping your requirements in mind.