

How to Measure Chaise Lounge Covers - Design 5

Measurement Instruction

- ✓ Give exact measurement from edge to edge.
- ✓ We add upto 2" leeway on the given width/depth for easy pull-in and pull-out.
- ✓ The height dimensions will remain same as provided by you.

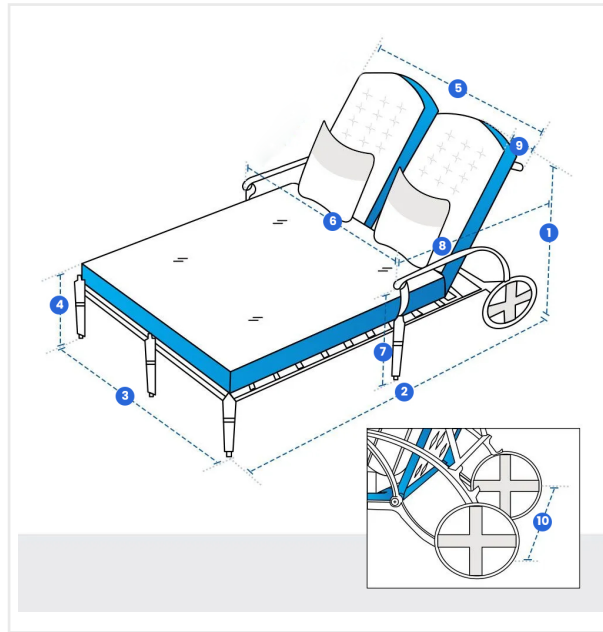

Measurement (Inches)

1. Back Height	<input type="text"/>	2. Depth	<input type="text"/>
3. Front Height	<input type="text"/>	4. Front Height	<input type="text"/>
5. Back Width	<input type="text"/>	6. Arm to Arm Width	<input type="text"/>
7. Arm Height	<input type="text"/>	8. Arm Depth	<input type="text"/>
9. Cushion Depth	<input type="text"/>	10. Wheel to Wheel Width	<input type="text"/>

1. Back Height:
Back Height of the Chaise

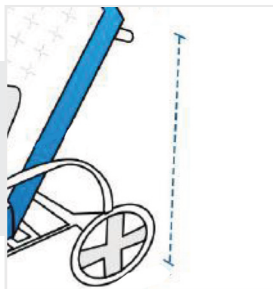

2. Depth:
Depth of the Custom Adirondack Chair

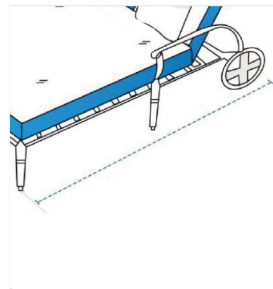

3. Front Height:
Front Height of the Chaise

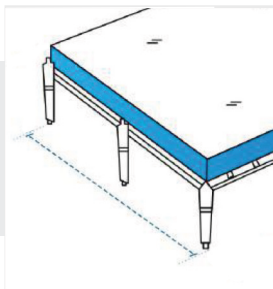

4. Width
Height from ground to arm of the Custom Adirondack Chair

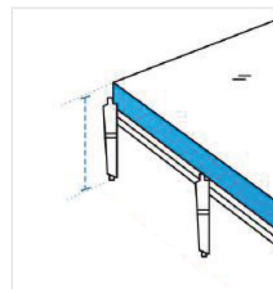

5. Arm to Back Width:
Arm to Arm Width of the Chaise

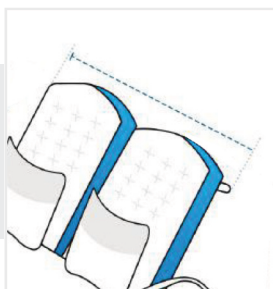

6. Arm to Arm Width:
Arm to Arm Width of the Chaise



7. Arm Height

Arm to Arm Height of the Chaise

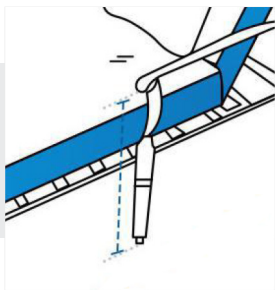

8. Cushion Depth

Cushion Depth of Chaise



10. Cushion Depth

Cushion Depth of the Chaise



11. Wheel to Wheel Width:

Wheel to Wheel Width of the Chaise

