

How to Measure Custom Adirondack Chair Covers - Design 7

Measurement Instruction

- ✓ Give exact measurement from edge to edge.
- ✓ We add 1" to 2" leeway on the given width/depth for easy pull-in and pull-out.
- ✓ The height dimensions will remain same as provided by you.

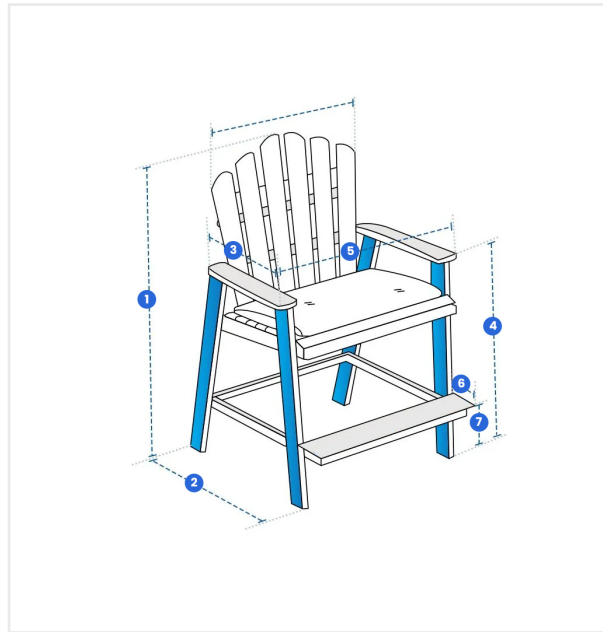

Measurement (Inches)

1. Back Height	<input type="text"/>	2. Depth	<input type="text"/>
3. Depth of Arm	<input type="text"/>	4. Height from ground to arm	<input type="text"/>
5. Arm to Arm Width	<input type="text"/>	6. Legrest Depth	<input type="text"/>
7. Height from ground to Legrest	<input type="text"/>	8. Back Width	<input type="text"/>

1. Back Height:
Back Height of the Custom Adirondack Chair

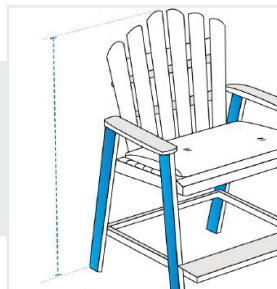

2. Depth:
Depth of the Custom Adirondack Chair

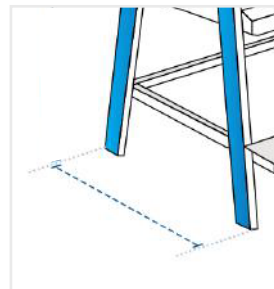

3. Depth of Arm:
Depth of Arm of the Custom Adirondack Chair

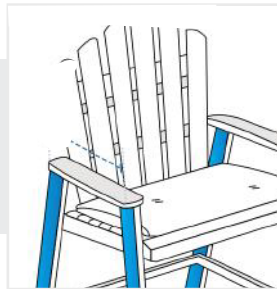

4. Height from ground to arm:
Height from ground to arm of the Custom Adirondack Chair

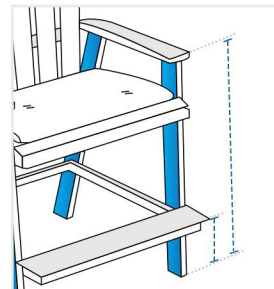

5. Arm to Arm Width:
Arm to Arm Width of the Custom Adirondack Chair



6. Legrest Depth:
Legrest Depth of the Custom Adirondack Chair

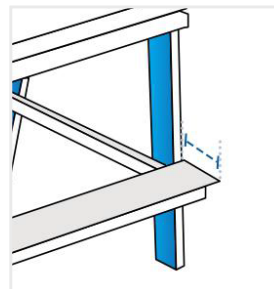

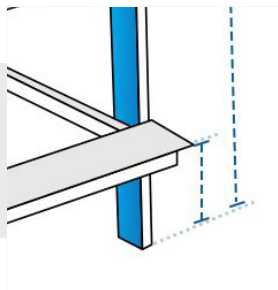

8. Height from ground to legrest:

Height from ground to legrest of the Custom Adirondack Chair

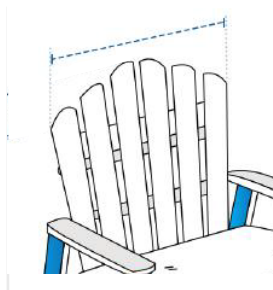

9. Back Width:

Back Width of the Custom Adirondack Chair