

How to Measure 32-35 inch TV Covers

Measurement Instruction

- ✓ Give exact measurement from edge to edge.
- ✓ We add 0" to 1" leeway on the given width/depth for easy pull-in and pull-out.
- ✓ The height dimensions will remain same as provided by you.

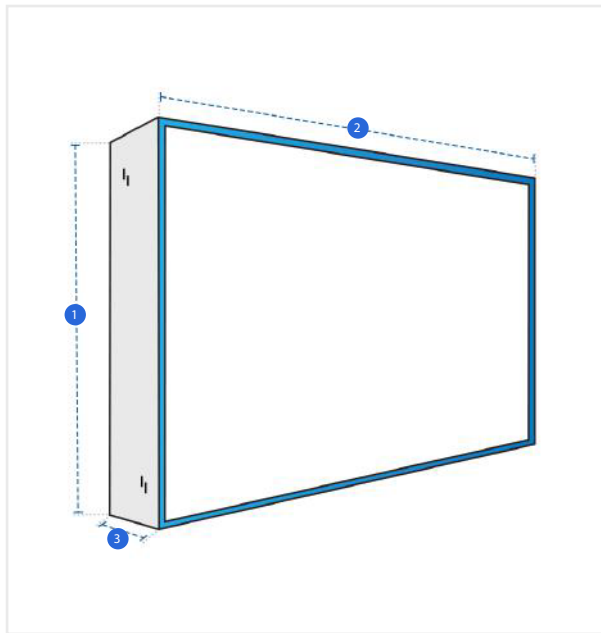

Measurement (Inches)

1. Height

2. Width

3. Depth

1. Height:
Height of the TV

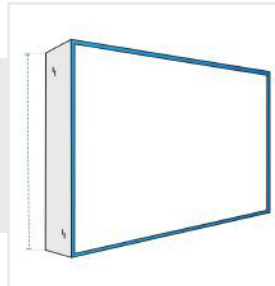

2. Width:
Width of the TV

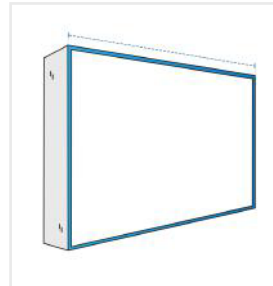

3. Depth:
Depth of the TV

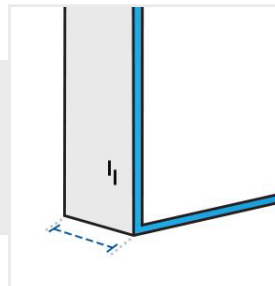

We encourage you to upload the image of the article you need the cover for - this helps our team ensure covers are designed keeping your requirements in mind.